

Frigerio

TAYLOR JUNIOR SOFA

Design R&D Frigerio

Dal forte carattere contemporaneo, il divanetto Taylor Junior nasce dall'omonima collezione mantenendo i giochi di volumi pieni dall'inata eleganza ma in dimensioni più compatte. Disponibile in un'unica misura di divano e nella versione poltrona. Si caratterizza per il tipico basamento in metallo e dalle cuciture sartoriali a "pizzicotto", perfetto simbolo dell'attitudine sartoriale di Frigerio.

With a strong contemporary character, Taylor Junior small sofa and loveseat comes from the namesake collection by keeping the dynamics of the volumes and its natural elegance yet in more compact dimensions. It is available in one size sofa and in the armchair version. It features the typical metal base and the sewing "pizzicotto", a perfect symbol of the tailoring attitude of Frigerio.



TAYLOR

Base della struttura: legno multistrato imbottito in poliuretano espanso indeformabile rivestito in tessuto protettivo accoppiato. Il modello è dotato di piedini centrali di sicurezza.

Braccioli: legno multistrato imbottito in poliuretano espanso indeformabile rivestito con trapuntino in piuma d'oca (Assopiuma).

Schienali: legno multistrato e metallo imbottiti in poliuretano espanso indeformabile rivestito con trapuntino in piuma d'oca (Assopiuma).

Cuscino seduta: piuma d'oca (Assopiuma) con inserto in poliuretano indeformabile.

Cuscinetti: piuma d'oca (Assopiuma).

Basamento: metallo color nero lucido.

Rivestimento: con cucitura Pizzicotto, sfoderabile in tessuto, fisso in pelle.

VERSIONE TAYLOR MEDIUM: versione con schienale fisso, profondità 102 cm, altezza schienale 69 cm.

VERSIONE TAYLOR LARGE: versione con schienale fisso, profondità 112 cm, altezza schienale 69 cm.

VERSIONE TAYLOR UP MEDIUM: versione con schienale rialzabile con meccanismo, profondità 102 cm (con schienale rialzato 107 cm), altezza schienale 69/87 cm.

VERSIONE TAYLOR UP LARGE: versione con schienale rialzabile con meccanismo, profondità 112 cm (con schienale rialzato 117 cm), altezza schienale 69/87 cm.

ACCESSORI:

| **mensole:** elementi che possono essere posizionati ai lati o nella parte posteriore del divano. Rivestimento in cuoio con cuciture tono su tono e bordi color wengé.

| **cabinet:** elemento cabinet in legno color wengé.

Base of the structure: plywood padded with nondeformable polyurethane foam covered with doubled protective fabric. The model is provided with central security feet.

Armrests: plywood padded with non-deformable polyurethane foam covered with quilt in goose down (Assopiuma).

Backrests: plywood and metal padded with nondeformable polyurethane foam covered with quilt in goose down (Assopiuma).

Seat cushion: goose down (Assopiuma) with core in non-deformable polyurethane foam.

Small cushions: goose down (Assopiuma).

Base: metal glossy black colour.

Cover: with Pizzicotto sewing, partially removable in fabric, fix in leather.

VERSION TAYLOR MEDIUM: version with fixed back, depth 102 cm, back height 69 cm.

VERSION TAYLOR LARGE: version with fixed back, depth 112 cm, back height 69 cm.

VERSION TAYLOR UP MEDIUM: version with adjustable back in height with mechanism, depth 102 cm (with raised back depth 107 cm), back height 69/87 cm.

VERSION TAYLOR UP LARGE: version with adjustable back in height with mechanism, depth 112 cm (with raised back depth 117 cm), back height 69/87 cm.

ACCESSORI:

| **shelves:** elements which can be placed at the sides or at the back of the sofa. Covered in hide leather with stitches tone-on-tone and edges in wengé colour.

| **cabinet:** cabinet element in wood colour wengé.

TAYLOR JUNIOR

Base della struttura: legno multistrato imbottito in poliuretano espanso indeformabile rivestito in tessuto protettivo accoppiato. Il modello è dotato di piedini centrali di sicurezza.

Braccioli: legno multistrato imbottito in poliuretano espanso indeformabile rivestito con trapuntino in piuma d'oca (Assopiuma).

Schienale: legno multistrato e metallo imbottiti in poliuretano espanso indeformabile rivestito con trapuntino in piuma d'oca (Assopiuma).

Cuscino seduta: piuma d'oca (Assopiuma) con inserto in poliuretano indeformabile.

Basamento: metallo color nero lucido.

Rivestimento: con cucitura Pizzicotto, sfoderabile in tessuto, fisso in pelle.

Base of the structure: plywood padded with nondeformable polyurethane foam covered with doubled protective fabric. The model is provided with central security feet.

Armrests: plywood padded with non-deformable polyurethane foam covered with quilt in goose down (Assopiuma).

Backrest: plywood and metal padded with nondeformable polyurethane foam covered with quilt in goose down (Assopiuma).

Seat cushion: goose down (Assopiuma) with core in non-deformable polyurethane foam.

Base: metal glossy black colour.

Cover: with Pizzicotto sewing, partially removable in fabric, fix in leather.

TAYLOR



TAYLOR MEDIUM d. 102 cm

Collezione di divani ed elementi profondi cm 102 con schienali fissi, non rialzabili, dotati di cuscinetti in piuma art. TP cm 47X47 e art. TA cm 65x35. Taylor Medium è utilizzabile in combinazione con Taylor Large, Taylor UP Medium e Taylor UP Large.

Collection of sofas and elements cm 102 deep, with fix backrests, non-adjustable in height, provided with goose down small cushions art. TP cm 47X47 and art. TA cm 65x35. Taylor Medium can be used in combination with Taylor Large, Taylor UP Medium and Taylor UP Large.



TAYLOR LARGE d. 112 cm

Collezione di divani ed elementi profondi cm 112 con schienali fissi, non rialzabili, dotati di cuscinetti in piuma art. TG cm 75x41, TP cm 47X47 e art. TA cm 65x35. Taylor Large è utilizzabile in combinazione con Taylor Medium, Taylor UP Medium e Taylor UP Large.

Collection of sofas and elements cm 112 deep, with fix backrests, non-adjustable in height, provided with goose down small cushions art. TG cm 75x41, TP cm 47X47 and art. TA cm 65x35. Taylor Large can be used in combination with Taylor Medium, Taylor UP Medium and Taylor UP Large.

TAYLOR UP



TAYLOR UP MEDIUM d. 102 cm

Collezione di divani ed elementi profondi cm 102 con schienali rialzabili, dotati di cuscinetti in piuma art. TP cm 47X47 e art. TA cm 65x35. Taylor UP Medium è utilizzabile in combinazione con Taylor Medium, Taylor Large e Taylor UP Large.

Collection of sofas and elements cm 102 deep, with backrests adjustable in height, provided with goose down small cushions art. TP cm 47X47 and art. TA cm 65x35. Taylor UP Medium can be used in combination with Taylor Medium, Taylor Large and Taylor UP Large.



TAYLOR UP LARGE d. 112 cm

Collezione di divani ed elementi profondi cm 112 con schienali rialzabili, dotati di cuscinetti in piuma art. TG cm 75x41, TP cm 47X47 e art. TA cm 65x35. Taylor UP Large è utilizzabile in combinazione con Taylor Medium, Taylor Large e Taylor UP Medium.

Collection of sofas and elements cm 112 deep, with backrests adjustable in height, provided with goose down small cushions art. TG cm 75x41, TP cm 47X47 and art. TA cm 65x35. Taylor UP Large can be used in combination with Taylor Medium, Taylor Large and Taylor UP Medium.

TAYLOR JUNIOR d. 83 cm



TAYLOR JUNIOR POLTRONA / ARMCHAIR

La collezione Taylor è costituita da una poltrona profondità cm 83, con schienale fisso.

Taylor collection consists of an armchair depth cm 83, with a fixed backrest.



TAYLOR JUNIOR DIVANETTO / SMALL SOFA

La collezione Taylor è costituita da un divanetto profondità cm 83, con schienale fisso.

Taylor collection consists of a small sofa depth cm 83, with a fixed backrest.

TAYLOR DETTAGLI / DETAILS

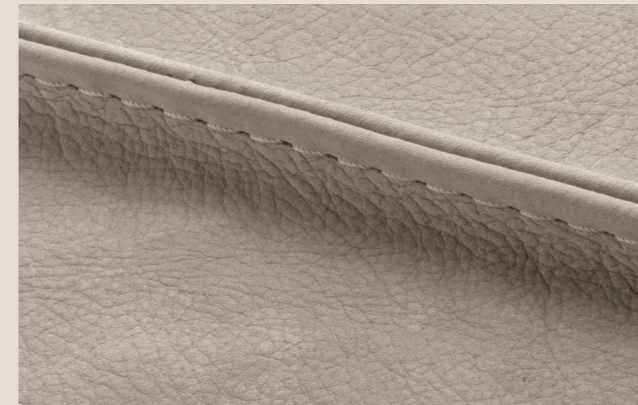

PIZZICOTTO

Le fodere di Taylor (Medium e Large) e Taylor UP (Medium e Large), sia nella versione in tessuto che nella versione in pelle, sono caratterizzate dalla cucitura a Pizzicotto.

The covers of Taylor (Medium and Large) and Taylor UP (Medium and Large), in both versions fabric and leather, are characterized by the Pizzicotto sewing.

TAYLOR MEDIUM SOFA

Design R&D Frigerio

TAYLOR MEDIUM FIX BACK / d. 102 cm



DIVANI / SOFAS

12900 12901 12902 12903

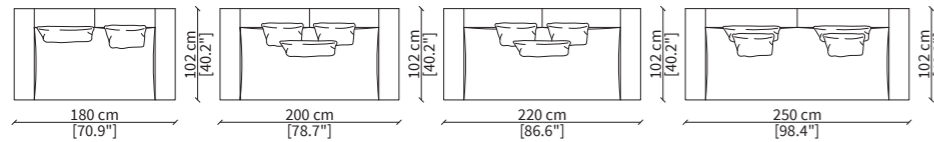

DIVANO PER TOP / SOFA FOR TOP

12904

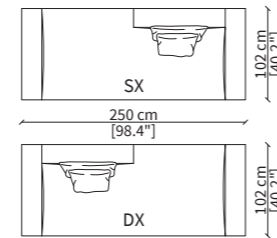

ELEMENTI TERMINALI / TERMINAL ELEMENTS

12905 12906 12907 12908

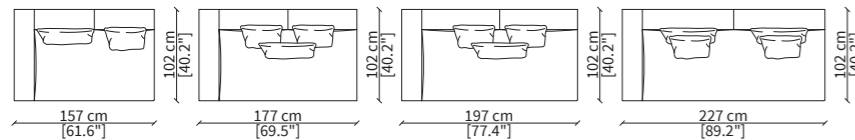

ELEMENTI CENTRALI / CENTRAL ELEMENTS

12909 12910 12911

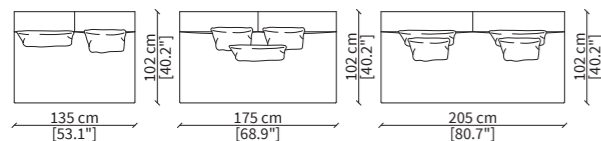

DORMEUSES

12912 12913 12914

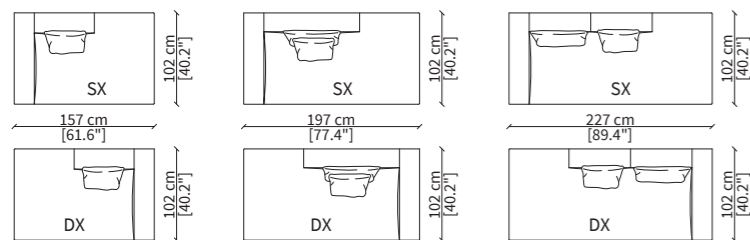

DORMEUSES PER TOP / DORMEUSES FOR TOP

12915

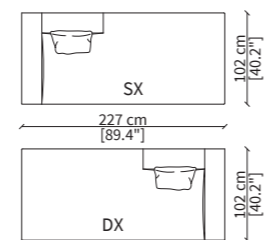

Dimensioni espresse in cm se non diversamente indicato.
L'Azienda si riserva il diritto di apportare modifiche ai modelli senza preavviso.
Tolleranza sulle misure indicate di +/- 2%.

Dimensions in centimeter if not differently indicated.
The Company reserves the right to change the models without any advance notice.
Tolerance on the given sizes +/- 2%.

TAYLOR MEDIUM SOFA

Design R&D Frigerio

CENTRALI DORMEUSE / CENTRAL DORMEUSES

12916 12917 12918

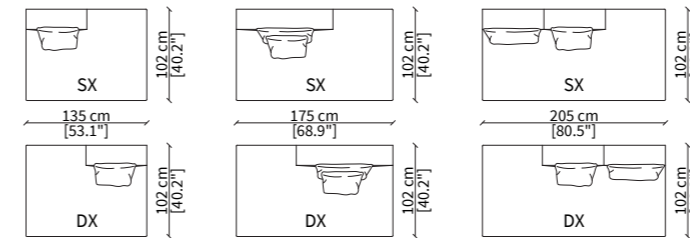

CENTRALE DORMEUSE PER TOP / CENTRAL DORMEUSE FOR TOP

12919

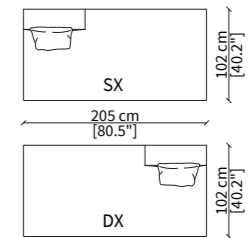

CHAISES LONGUE

12921 12920

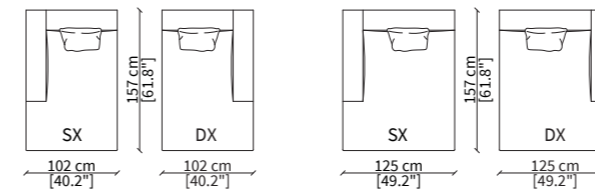

CHAISE LONGUE CENTRALE / CENTRAL CHAISE LONGUE

12922

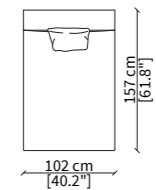

ELEMENTI LONGUE / LONGUE ELEMENTS

12709 12710 12711

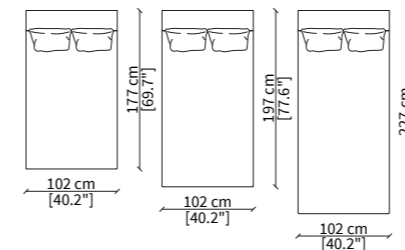

ELEMENTO ANGOLO / CORNER ELEMENT

12923

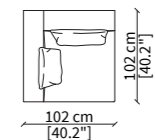

POUFS

12735 12736 12737

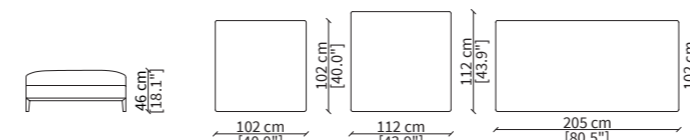

12738 12739 12740

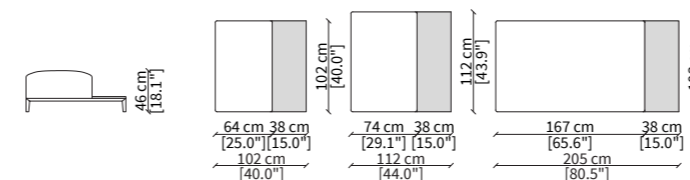

13302 13303 13304

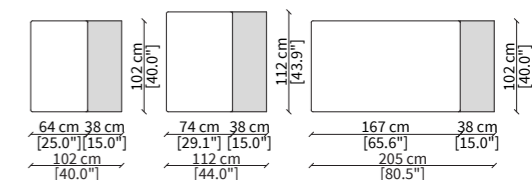

Dimensioni espresse in cm se non diversamente indicato.
L'Azienda si riserva il diritto di apportare modifiche ai modelli senza preavviso.
Tolleranza sulle misure indicate di +/- 2%.

Dimensions in centimeter if not differently indicated.
The Company reserves the right to change the models without any advance notice.
Tolerance on the given sizes +/- 2%.

TAYLOR MEDIUM SOFA Design R&D Frigerio

MENSOLE LATERALI / SIDE SHELVES

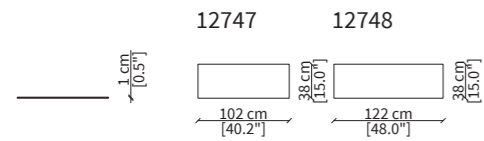

MENSOLE SCHIENALE / BACK SHELVES

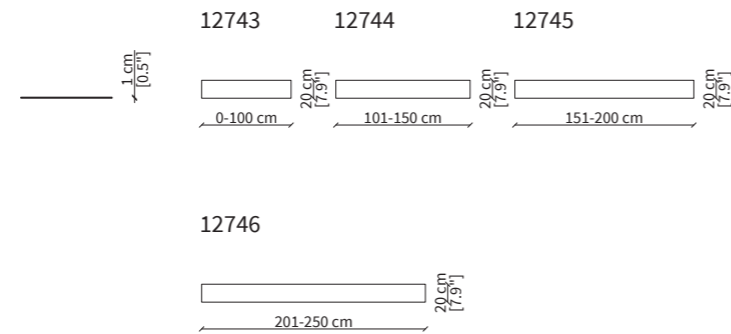

CABINET

12749M

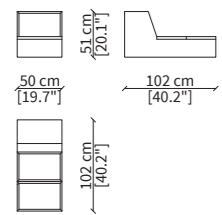

LAMPADA / LAMP

TYDA

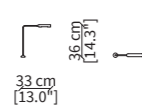

CUSCINI / CUSHIONS

TP TA



14034 14035

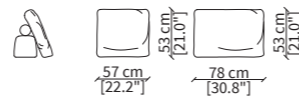

ESEMPI DI COMPOSIZIONE AD ANGOLO / EXAMPLES OF CORNER COMPOSITIONS

Le composizioni ad angolo possono essere così realizzate:
Corner composition can be built as follows:

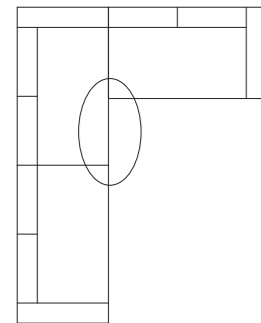

1. accostando tra loro gli elementi. Sugeriamo l'aggiunta di un cuscino schienale per maggior comfort nell'angolo.

1. by combining the elements. We recommend adding an extra back cushion for a better comfort in the corner.

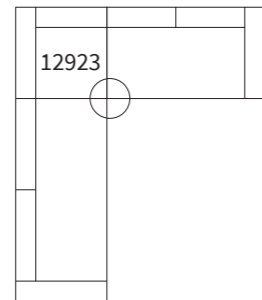

2. utilizzando l'angolo (art. **12923**) per un allineamento preciso delle sedute.

2. by using the corner (art. **12923**) for a perfect alignment of the seats.

ESEMPI DI COMPOSIZIONE CON MENSOLE / EXAMPLES OF COMPOSITIONS WITH SHELVES

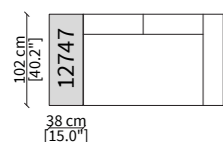

1. mensola laterale (art. **12747**).
1. side shelf (art. **12747**).

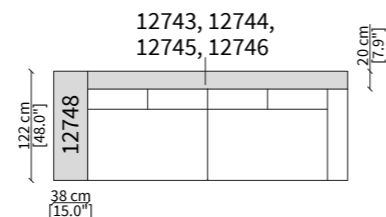

2. mensola laterale (art. **12748**) e mensola schienale.
2. side shelf (art. **12748**) and back shelf.

TAYLOR MEDIUM SOFA Design R&D Frigerio

COMPOSIZIONE 1 / COMPOSITION 1

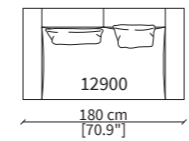

CODICI / CODES: **12900**

COMPOSIZIONE 2 / COMPOSITION 2

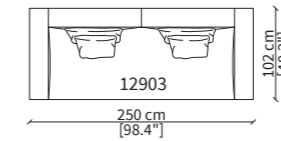

CODICI / CODES: **12903**

COMPOSIZIONE 3 / COMPOSITION 3

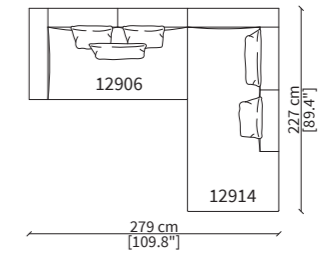

CODICI / CODES: **12906, 12914**

COMPOSIZIONE 4 / COMPOSITION 4

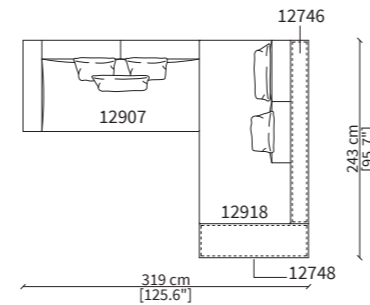

CODICI / CODES: **12907, 12746, 12918, 12748**

COMPOSIZIONE 5 / COMPOSITION 5

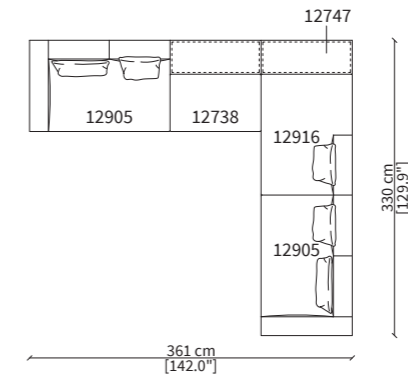

CODICI / CODES: **12905 x 2, 12738, 12747, 12916**

COMPOSIZIONE 6 / COMPOSITION 6

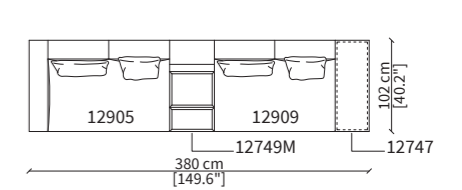

CODICI / CODES: **12905, 12749M, 12909, 12747**

TAYLOR LARGE SOFA

Design R&D Frigerio

TAYLOR LARGE FIX BACK / d. 112 cm



DIVANI / SOFAS

13000 13001 13002 13003

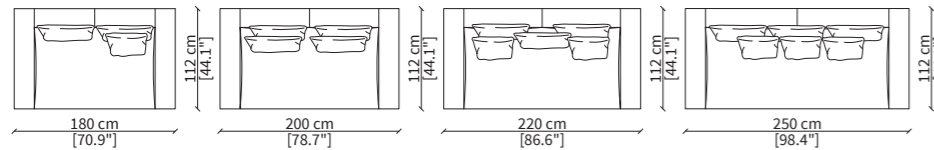

DIVANO PER TOP / SOFA FOR TOP

13004

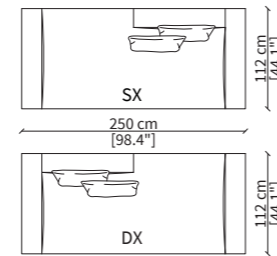

ELEMENTI TERMINALI / TERMINAL ELEMENTS

13005 13006 13007 13008

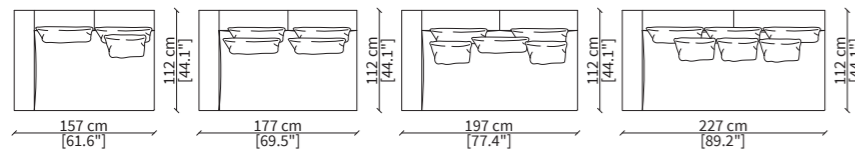

ELEMENTI CENTRALI / CENTRAL ELEMENTS

13009 13010 13011

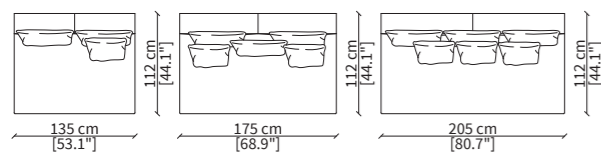

DORMEUSES

13012 13013 13014

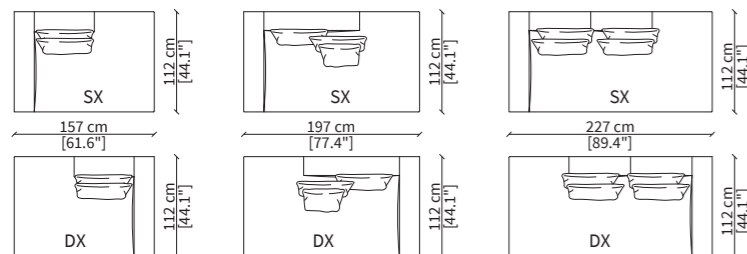

DORMEUSES PER TOP / DORMEUSES FOR TOP

13015

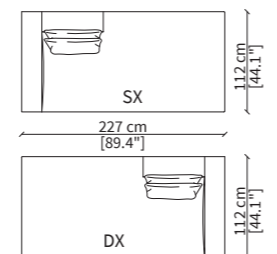

Dimensioni espresse in cm se non diversamente indicato.
L'Azienda si riserva il diritto di apportare modifiche ai modelli senza preavviso.
Tolleranza sulle misure indicate di +/- 2%.

Dimensions in centimeter if not differently indicated.
The Company reserves the right to change the models without any advance notice.
Tolerance on the given sizes +/- 2%.

TAYLOR LARGE SOFA

Design R&D Frigerio

CENTRALI DORMEUSE / CENTRAL DORMEUSES

13016 13017 13018

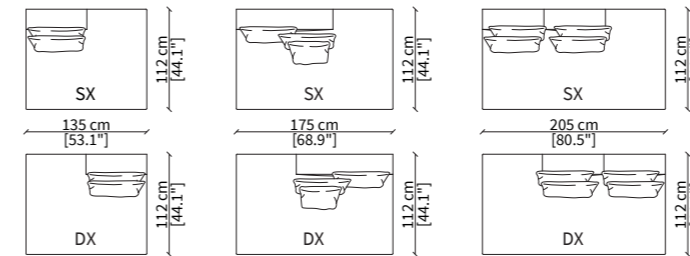

CENTRALE DORMEUSE PER TOP / CENTRAL DORMEUSE FOR TOP

13019

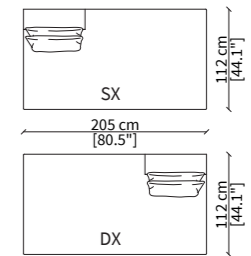

CHAISES LONGUE

12921 12920

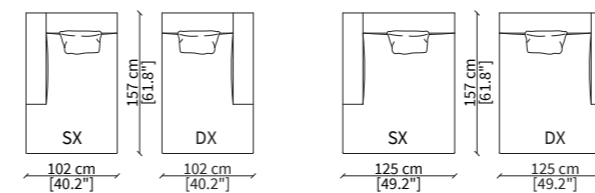

CHAISE LONGUE CENTRALE / CENTRAL CHAISE LONGUE

12922

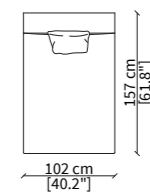

ELEMENTI LONGUE / LONGUE ELEMENTS

12709 12710 12711

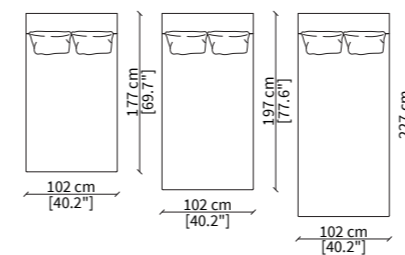

ELEMENTO ANGOLO / CORNER ELEMENT

13020

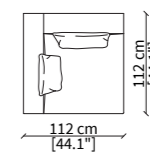

POUFS

12735 12736 12737

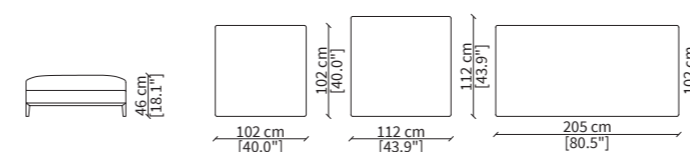

12738 12739 12740

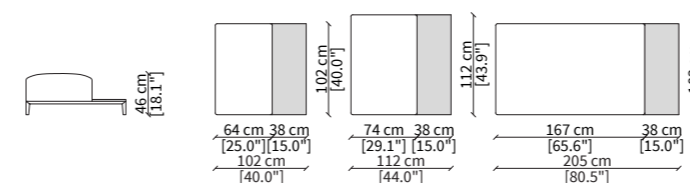

13302 13303 13304

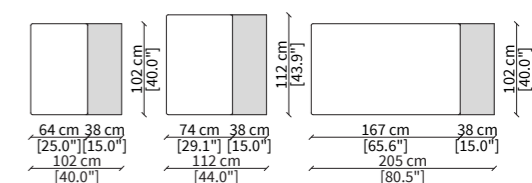

Dimensioni espresse in cm se non diversamente indicato.
L'Azienda si riserva il diritto di apportare modifiche ai modelli senza preavviso.
Tolleranza sulle misure indicate di +/- 2%.

Dimensions in centimeter if not differently indicated.
The Company reserves the right to change the models without any advance notice.
Tolerance on the given sizes +/- 2%.

TAYLOR LARGE SOFA Design R&D Frigerio

MENSOLE LATERALI / SIDE SHELVES

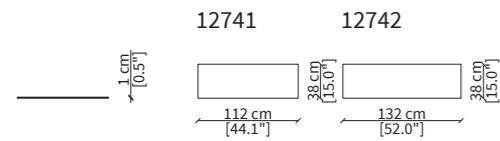

MENSOLE SCHIENALE / BACK SHELVES

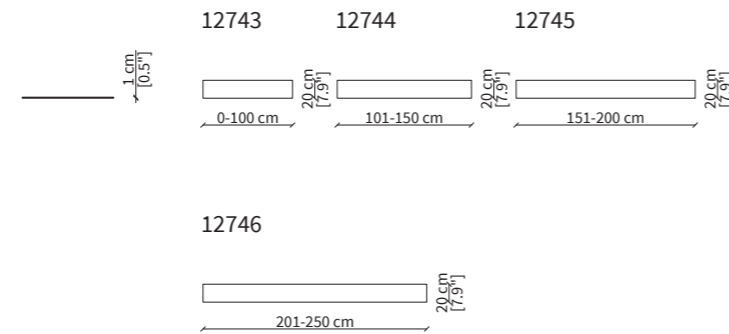

CABINET

12749L

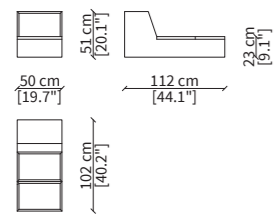

LAMPADA / LAMP

TYDA

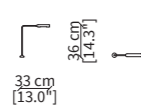

CUSCINI / CUSHIONS

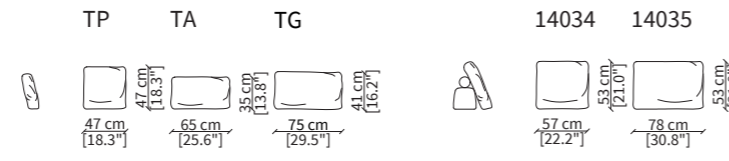

ESEMPI DI COMPOSIZIONE AD ANGOLO / EXAMPLES OF CORNER COMPOSITIONS

Le composizioni ad angolo possono essere così realizzate:
Corner composition can be built as follows:

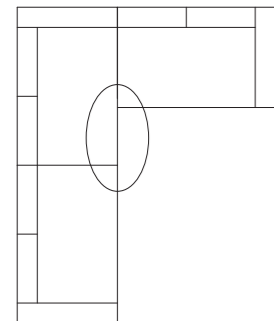

1. accostando tra loro gli elementi. Sugeriamo l'aggiunta di un cuscino schienale per maggior comfort nell'angolo.

1. by combining the elements. We recommend adding an extra back cushion for a better comfort in the corner.

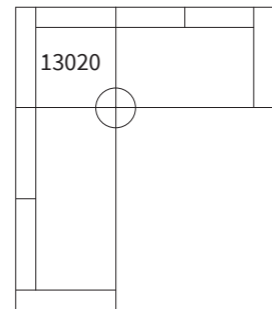

2. utilizzando l'angolo (art. **13020**) per un allineamento preciso delle sedute.

2. by using the corner (art. **13020**) for a perfect alignment of the seats.

ESEMPI DI COMPOSIZIONE CON MENSOLE / EXAMPLES OF COMPOSITIONS WITH SHELVES

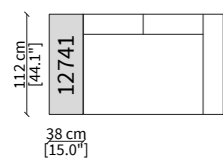

1. mensola laterale (art. **12741**).
1. side shelf (art. **12741**).

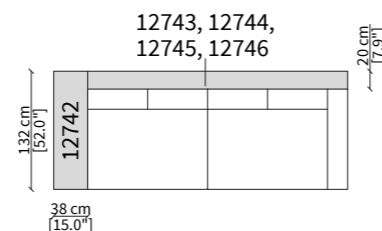

2. mensola laterale (art. **12742**) e mensola schienale.
2. side shelf (art. **12742**) and back shelf.

TAYLOR LARGE SOFA Design R&D Frigerio

COMPOSIZIONE 1 / COMPOSITION 1

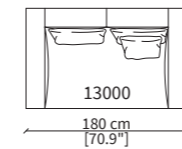

CODICI / CODES: **13000**

COMPOSIZIONE 2 / COMPOSITION 2

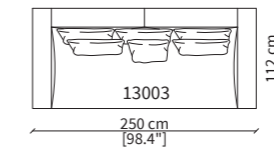

CODICI / CODES: **13003**

COMPOSIZIONE 3 / COMPOSITION 3

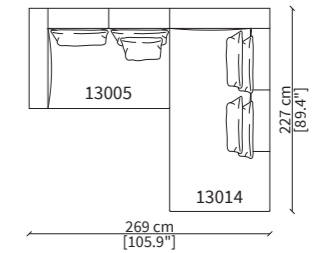

CODICI / CODES: **13005, 13014**

COMPOSIZIONE 4 / COMPOSITION 4

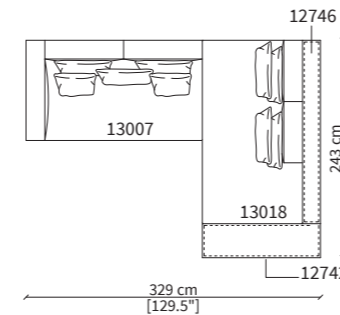

CODICI / CODES: **13007, 13018, 12746, 12742**

COMPOSIZIONE 5 / COMPOSITION 5

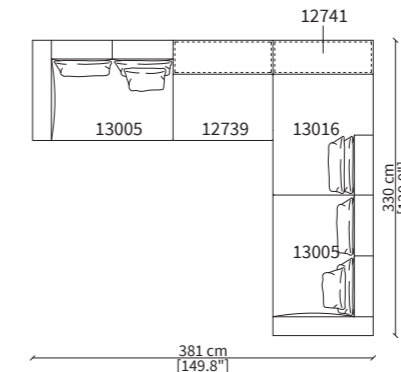

CODICI / CODES: **13005 x 2, 12739, 13016, 12741**

COMPOSIZIONE 6 / COMPOSITION 6

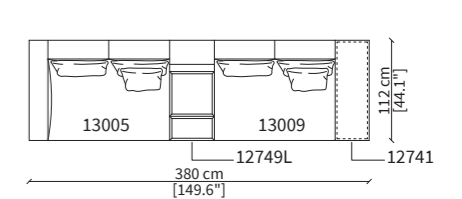

CODICI / CODES: **13005, 12749L, 13009, 12741**

TAYLOR UP MEDIUM SOFA

Design R&D Frigerio

TAYLOR UP MEDIUM UP BACK / d. 102 - 107 cm

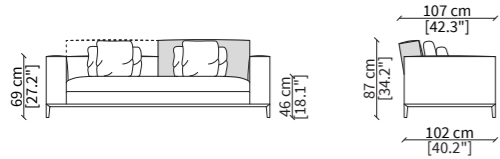

DIVANI / SOFAS

12700

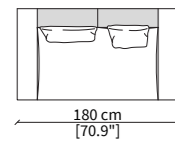

12701

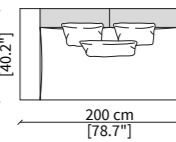

12702

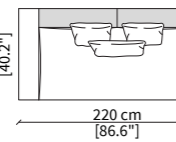

12703

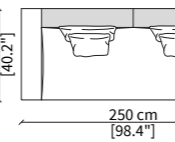

DIVANO PER TOP / SOFA FOR TOP

12704

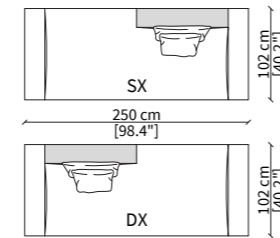

ELEMENTI TERMINALI / TERMINAL ELEMENTS

12705

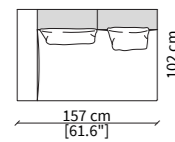

12706

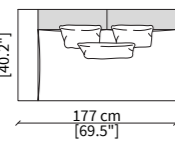

12707

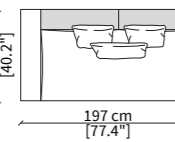

12708

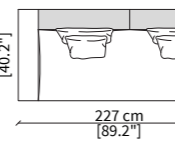

ELEMENTI CENTRALI / CENTRAL ELEMENTS

12712

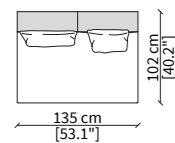

12713

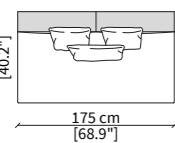

12714

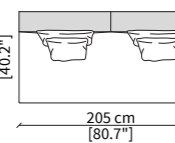

DORMEUSES

12715

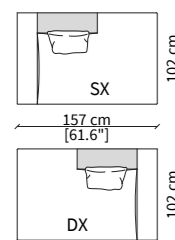

12716

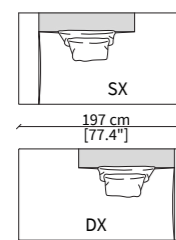

12717

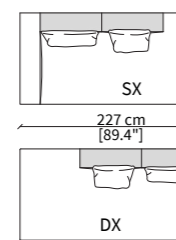

DORMEUSES PER TOP / DORMEUSES FOR TOP

12718

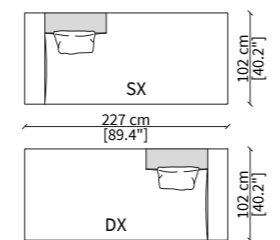

Dimensioni espresse in cm se non diversamente indicato.
L'Azienda si riserva il diritto di apportare modifiche ai modelli senza preavviso.
Tolleranza sulle misure indicate di +/- 2%.

Dimensions in centimeter if not differently indicated.
The Company reserves the right to change the models without any advance notice.
Tolerance on the given sizes +/- 2%.

TAYLOR UP MEDIUM SOFA

Design R&D Frigerio

CENTRALI DORMEUSE / CENTRAL DORMEUSES

12719

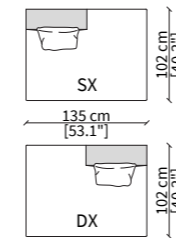

12720

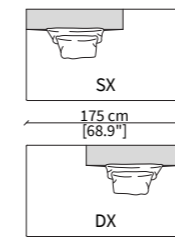

12721

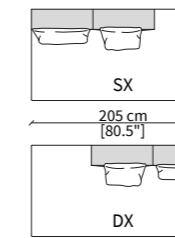

CENTRALE DORMEUSE PER TOP / CENTRAL DORMEUSE FOR TOP

12722

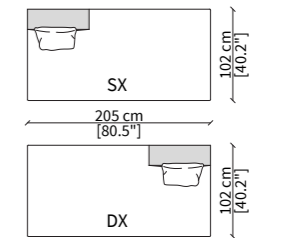

CHAISES LONGUE

12724

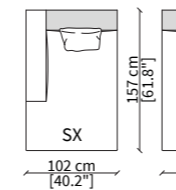

12723

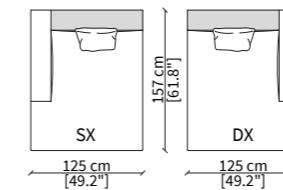

CHAISE LONGUE CENTRALE / CENTRAL CHAISE LONGUE

12725

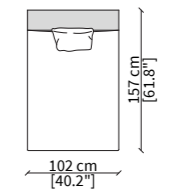

ELEMENTI LONGUE / LONGUE ELEMENTS

12709

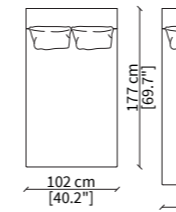

12710

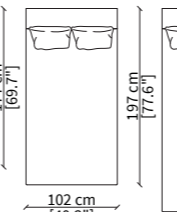

12711

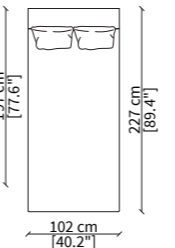

ELEMENTO ANGOLO / CORNER ELEMENT

12726

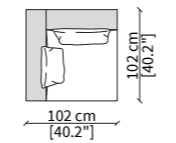

DIVANO ANGOLO / SOFA CORNER

12727

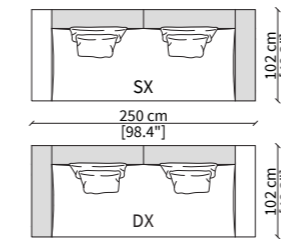

DIVANO ANGOLO PER TOP / SOFA CORNER FOR TOP

12728

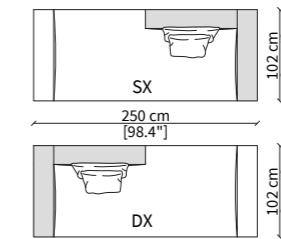

TERMINALE ANGOLO / TERMINAL CORNER

12729

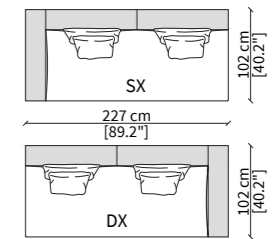

Dimensioni espresse in cm se non diversamente indicato.
L'Azienda si riserva il diritto di apportare modifiche ai modelli senza preavviso.
Tolleranza sulle misure indicate di +/- 2%.

Dimensions in centimeter if not differently indicated.
The Company reserves the right to change the models without any advance notice.
Tolerance on the given sizes +/- 2%.

TAYLOR UP MEDIUM SOFA Design R&D Frigerio

DORMEUSE ANGOLO / DORMEUSE CORNER 12733

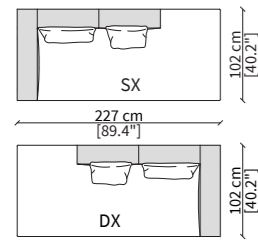

DORMEUSE ANGOLO PER TOP / DORMEUSE CORNER FOR TOP 12734

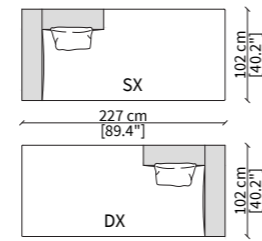

LONGUES ANGOLO / LONGUES CORNER 12730 12731 12732

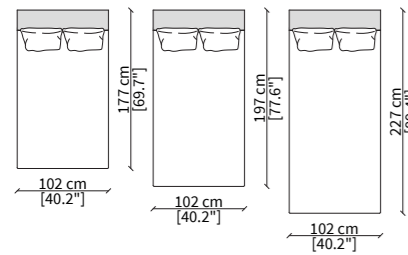

POUFS

12735 12736 12737

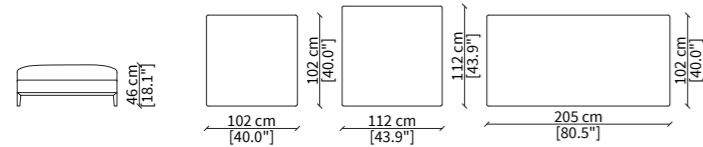

12738 12739 12740

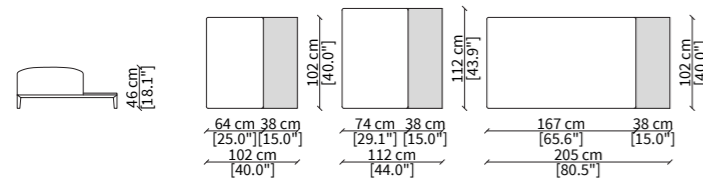

13302 13303 13304

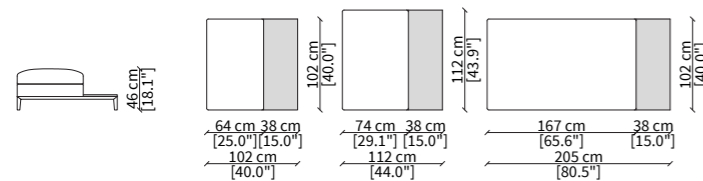

Dimensioni espresse in cm se non diversamente indicato.
L'Azienda si riserva il diritto di apportare modifiche ai modelli senza preavviso.
Tolleranza sulle misure indicate di +/- 2%.

Dimensions in centimeter if not differently indicated.
The Company reserves the right to change the models without any advance notice.
Tolerance on the given sizes +/- 2%.

TAYLOR UP MEDIUM SOFA Design R&D Frigerio

MENSOLE LATERALI / SIDE SHELVES

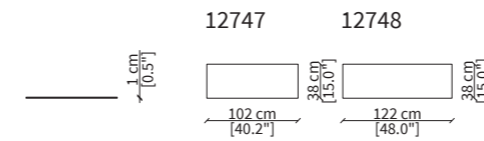

MENSOLE SCHIENALE / BACK SHELVES

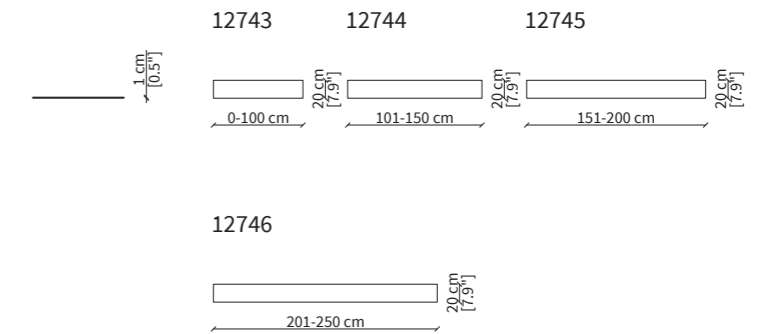

CABINET

12749M

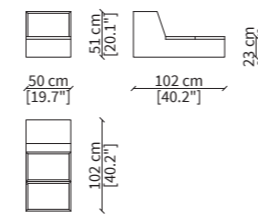

LAMPADA / LAMP

TYDA

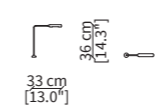

CUSCINI / CUSHIONS

TP TA



14034 14035

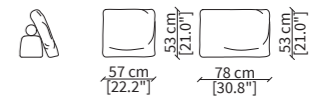

Dimensioni espresse in cm se non diversamente indicato.
L'Azienda si riserva il diritto di apportare modifiche ai modelli senza preavviso.
Tolleranza sulle misure indicate di +/- 2%.

Dimensions in centimeter if not differently indicated.
The Company reserves the right to change the models without any advance notice.
Tolerance on the given sizes +/- 2%.

TAYLOR UP MEDIUM SOFA Design R&D Frigerio

DETTAGLI DEGLI ELEMENTI ANGOLO / DETAILS OF ELEMENTS CORNER

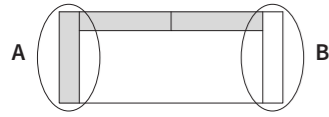

A angolo
corner

B bracciolo
armrest

ESEMPI DI COMPOSIZIONE AD ANGOLO / EXAMPLES OF CORNER COMPOSITIONS

Le composizioni ad angolo possono essere così realizzate:
Corner composition can be built as follows:

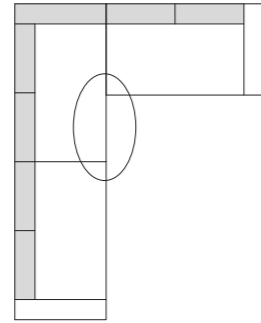

1. utilizzando gli elementi "divano angolo", "terminali angolo", "longues angolo" o "dormeuses angolo".

1. by using the elements "sofa corner", "terminals corner", "longues corner" or "dormeuses corner".

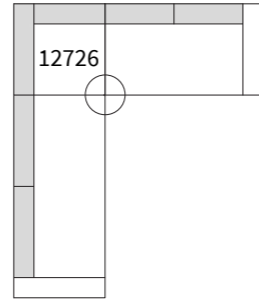

2. utilizzando l'angolo (art. **12726**) per un allineamento preciso delle sedute.

2. by using the corner (art. **12726**) for a perfect alignment of the seats.

ESEMPI DI COMPOSIZIONE CON MENSOLE / EXAMPLES OF COMPOSITIONS WITH SHELVES

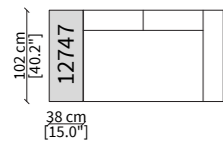

1. mensola laterale (art. **12747**).
1. side shelf (art. **12747**).

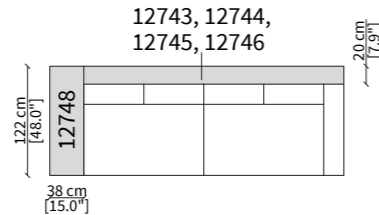

2. mensola laterale (art. **12748**) e mensola schienale.
2. side shelf (art. **12748**) and back shelf.

TAYLOR UP MEDIUM SOFA Design R&D Frigerio

COMPOSIZIONE 1 / COMPOSITION 1

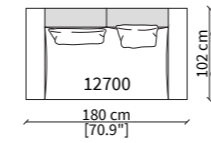

CODICI / CODES: **12700**

COMPOSIZIONE 2 / COMPOSITION 2

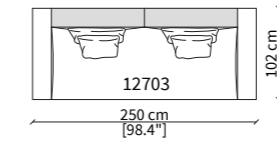

CODICI / CODES: **12703**

COMPOSIZIONE 3 / COMPOSITION 3

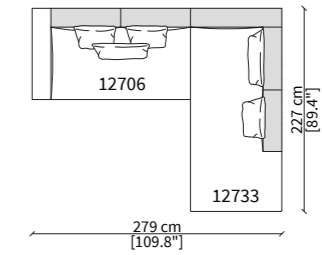

CODICI / CODES: **12706, 12733**

COMPOSIZIONE 4 / COMPOSITION 4

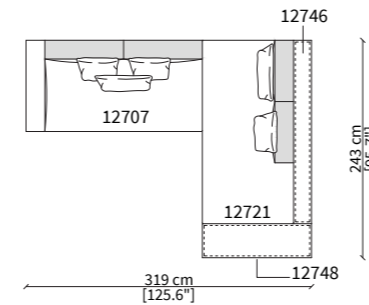

CODICI / CODES: **12707, 12721, 12746, 12748**

COMPOSIZIONE 5 / COMPOSITION 5

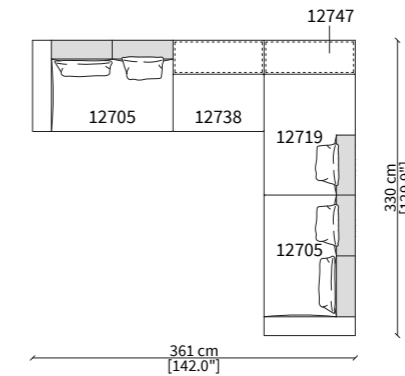

CODICI / CODES: **12705 x 2, 12738, 12719, 12747**

COMPOSIZIONE 6 / COMPOSITION 6

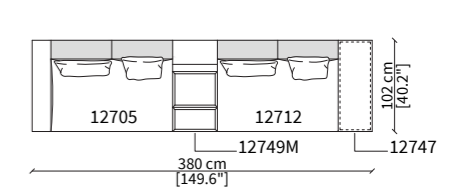

CODICI / CODES: **12705, 12749M, 12712, 12747**

TAYLOR UP LARGE SOFA

Design R&D Frigerio

TAYLOR UP LARGE UP BACK / d. 112 - 117 cm

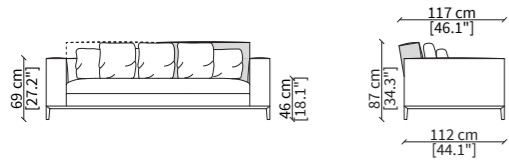

DIVANI / SOFAS

12800 12801 12802 12803

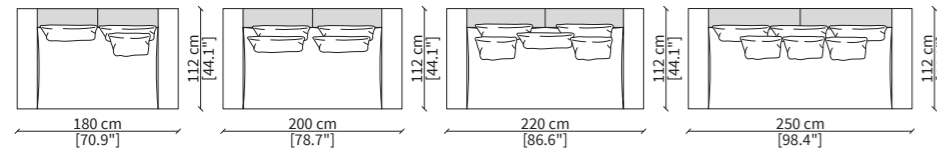

DIVANO PER TOP / SOFA FOR TOP

13004

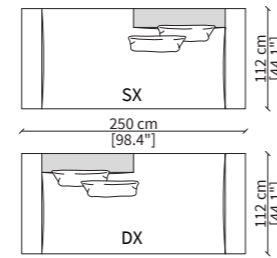

ELEMENTI TERMINALI / TERMINAL ELEMENTS

12805 12806 12807 12808

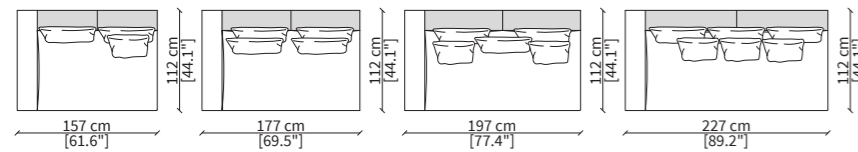

ELEMENTI CENTRALI / CENTRAL ELEMENTS

12809 12810 12811

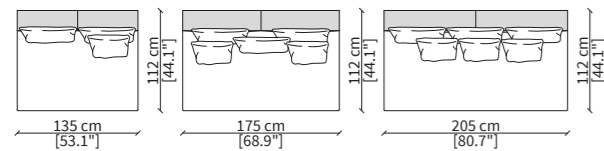

DORMEUSES

12812 12813 12814

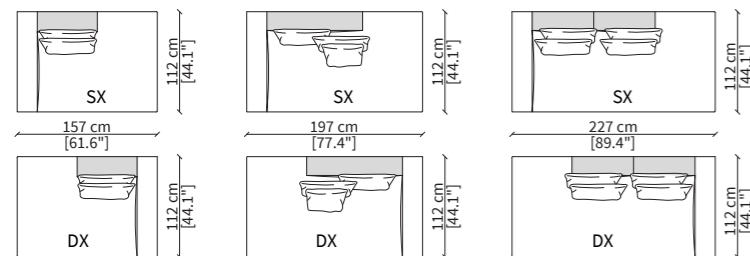

DORMEUSES PER TOP / DORMEUSES FOR TOP

12815

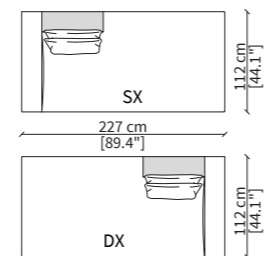

Dimensioni espresse in cm se non diversamente indicato.
L'Azienda si riserva il diritto di apportare modifiche ai modelli senza preavviso.
Tolleranza sulle misure indicate di +/- 2%.

Dimensions in centimeter if not differently indicated.
The Company reserves the right to change the models without any advance notice.
Tolerance on the given sizes +/- 2%.

TAYLOR UP LARGE SOFA

Design R&D Frigerio

CENTRALI DORMEUSE / CENTRAL DORMEUSES

12816 12817 12818

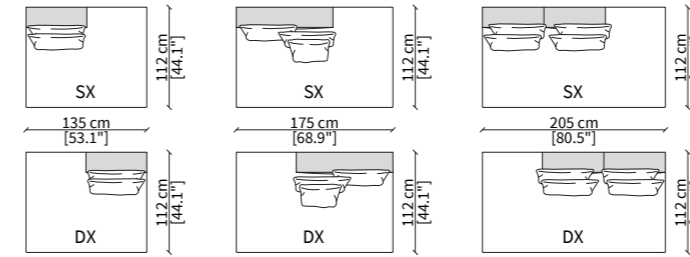

CENTRALE DORMEUSE PER TOP / CENTRAL DORMEUSE FOR TOP

12819

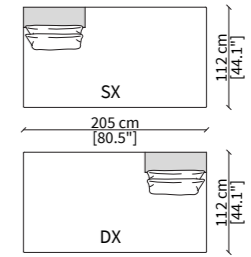

CHAISES LONGUE

12724 12723

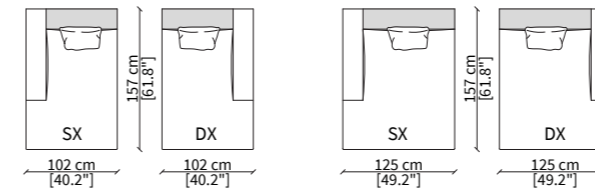

CHAISE LONGUE CENTRALE / CENTRAL CHAISE LONGUE

12725

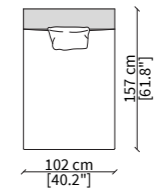

ELEMENTI LONGUE / LONGUE ELEMENTS

12709 12710 12711

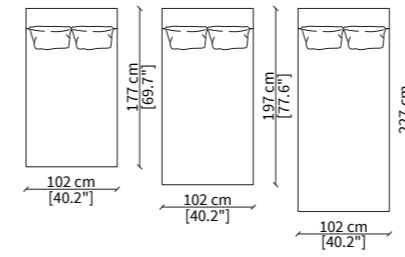

ELEMENTO ANGOLO / CORNER ELEMENT

12820

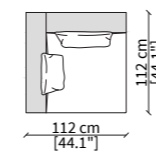

DIVANO ANGOLO / SOFA CORNER

12821

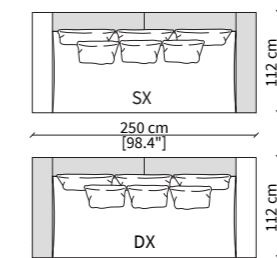

TERMINALE ANGOLO / TERMINAL CORNER

12822

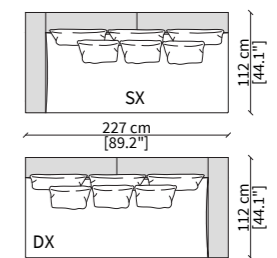

Dimensioni espresse in cm se non diversamente indicato.
L'Azienda si riserva il diritto di apportare modifiche ai modelli senza preavviso.
Tolleranza sulle misure indicate di +/- 2%.

Dimensions in centimeter if not differently indicated.
The Company reserves the right to change the models without any advance notice.
Tolerance on the given sizes +/- 2%.

TAYLOR UP LARGE SOFA Design R&D Frigerio

DORMEUSE ANGOLO / DORMEUSE CORNER 12823

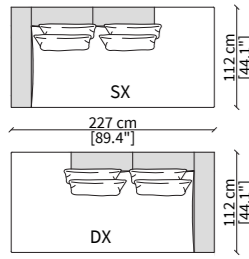

DORMEUSE ANGOLO PER TOP / DORMEUSE CORNER FOR TOP 12824

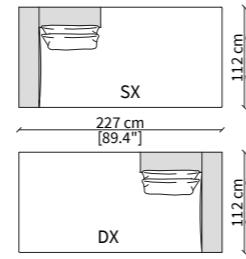

LONGUES ANGOLO / LONGUES CORNER 12730 12731 12732

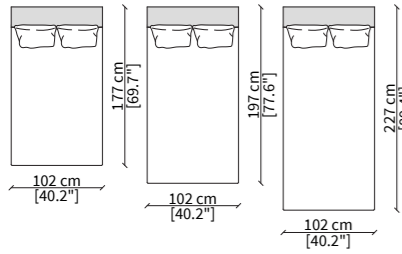

POUFS

12735 12736 12737

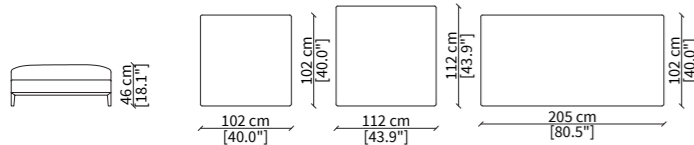

12738 12739 12740

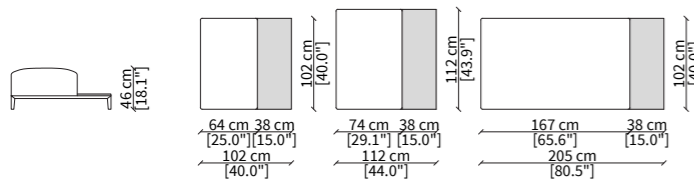

13302 13303 13304

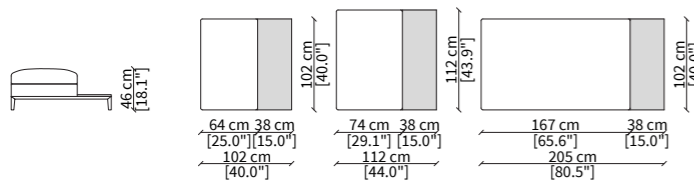

Dimensioni espresse in cm se non diversamente indicato.
L'Azienda si riserva il diritto di apportare modifiche ai modelli senza preavviso.
Tolleranza sulle misure indicate di +/- 2%.

Dimensions in centimeter if not differently indicated.
The Company reserves the right to change the models without any advance notice.
Tolerance on the given sizes +/- 2%.

TAYLOR UP LARGE SOFA Design R&D Frigerio

MENSOLE LATERALI / SIDE SHELVES

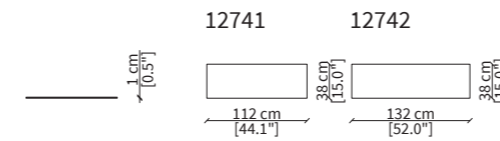

MENSOLE SCHIENALE / BACK SHELVES

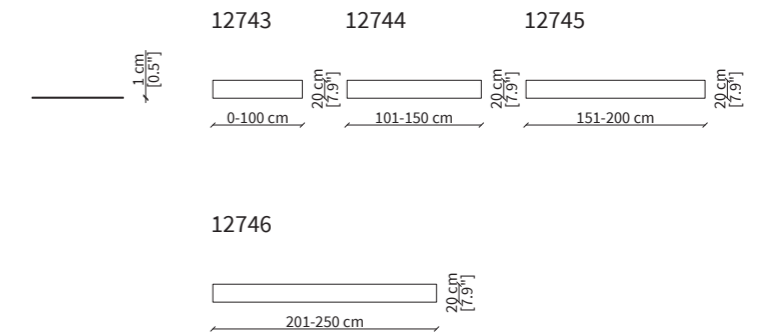

CABINET

12749L

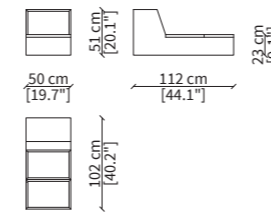

LAMPADA / LAMP

TYDA

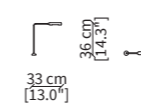

CUSCINI / CUSHIONS

TP TA TG

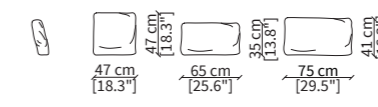

14034 14035

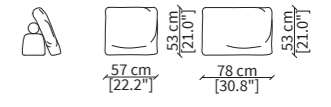

Dimensioni espresse in cm se non diversamente indicato.
L'Azienda si riserva il diritto di apportare modifiche ai modelli senza preavviso.
Tolleranza sulle misure indicate di +/- 2%.

Dimensions in centimeter if not differently indicated.
The Company reserves the right to change the models without any advance notice.
Tolerance on the given sizes +/- 2%.

TAYLOR UP LARGE SOFA Design R&D Frigerio

DETTAGLI DEGLI ELEMENTI ANGOLO / DETAILS OF ELEMENTS CORNER

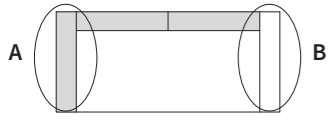

A angolo (rialzabile)
corner (raisable)

B bracciolo (non rialzabile)
armrest (not raisable)

ESEMPI DI COMPOSIZIONE AD ANGOLO / EXAMPLES OF CORNER COMPOSITIONS

Le composizioni ad angolo possono essere così realizzate:
Corner composition can be built as follows:

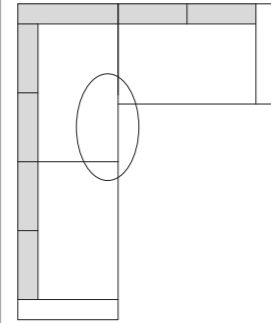

1. utilizzando gli elementi "divano angolo", "terminali angolo", "longues angolo" o "dormeuses angolo".

1. by using the elements "sofa corner", "terminals corner", "longues corner" or "dormeuses corner".

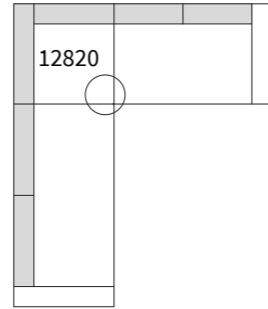

2. utilizzando l'angolo (art. **12820**) per un allineamento preciso delle sedute.

2. by using the corner (art. **12820**) for a perfect alignment of the seats.

ESEMPI DI COMPOSIZIONE CON MENSOLE / EXAMPLES OF COMPOSITIONS WITH SHELVES

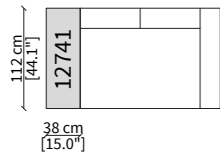

1. mensola laterale (art. **12741**).
1. side shelf (art. **12741**).

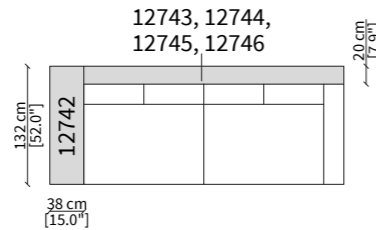

2. mensola laterale (art. **12742**) e mensola schienale.
2. side shelf (art. **12742**) and back shelf.

TAYLOR UP LARGE SOFA Design R&D Frigerio

COMPOSIZIONE 1 / COMPOSITION 1

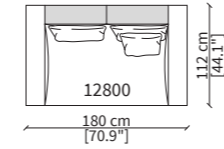

CODICI / CODES: **12700**

COMPOSIZIONE 2 / COMPOSITION 2

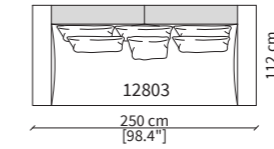

CODICI / CODES: **12703**

COMPOSIZIONE 3 / COMPOSITION 3

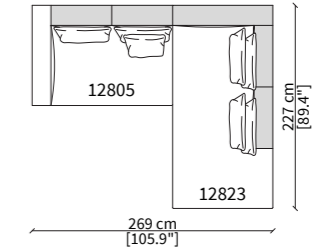

CODICI / CODES: **12706, 12733**

COMPOSIZIONE 4 / COMPOSITION 4

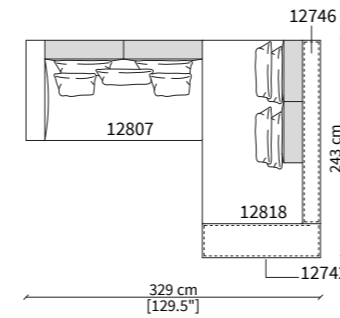

CODICI / CODES: **12707, 12721, 12746, 12748**

COMPOSIZIONE 5 / COMPOSITION 5

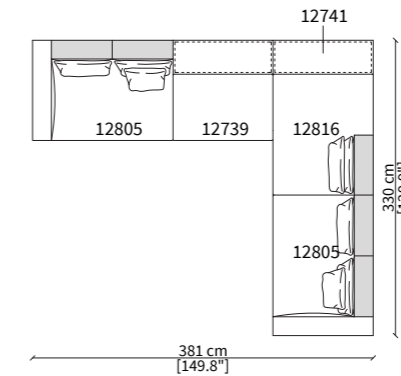

CODICI / CODES: **12705 x 2, 12738, 12719, 12747**

COMPOSIZIONE 6 / COMPOSITION 6

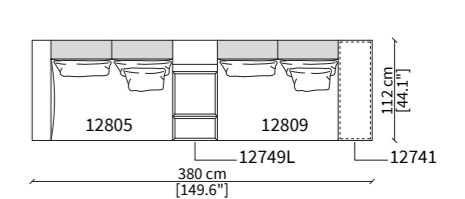

CODICI / CODES: **12705, 12749M, 12712, 12747**

TAYLOR JUNIOR SOFA

Design R&D Frigerio

TAYLOR JUNIOR - POLTRONA / ARMCHAIR / d. 83 cm

13300

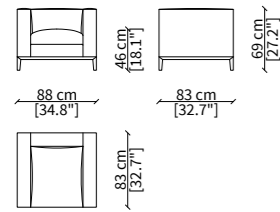

TAYLOR JUNIOR - DIVANETTO / SMALL SOFA / d. 83 cm

13301

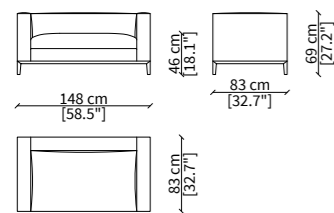

Dimensioni espresse in cm se non diversamente indicato.
L'Azienda si riserva il diritto di apportare modifiche ai modelli senza preavviso.
Tolleranza sulle misure indicate di +/- 2%.

Dimensions in centimeter if not differently indicated.
The Company reserves the right to change the models without any advance notice.
Tolerance on the given sizes +/- 2%.

Per la gamma completa di materiali è possibile consultare il nostro sito web www.frigerio.com
The full range of materials can be found on our website at www.frigerio.com.

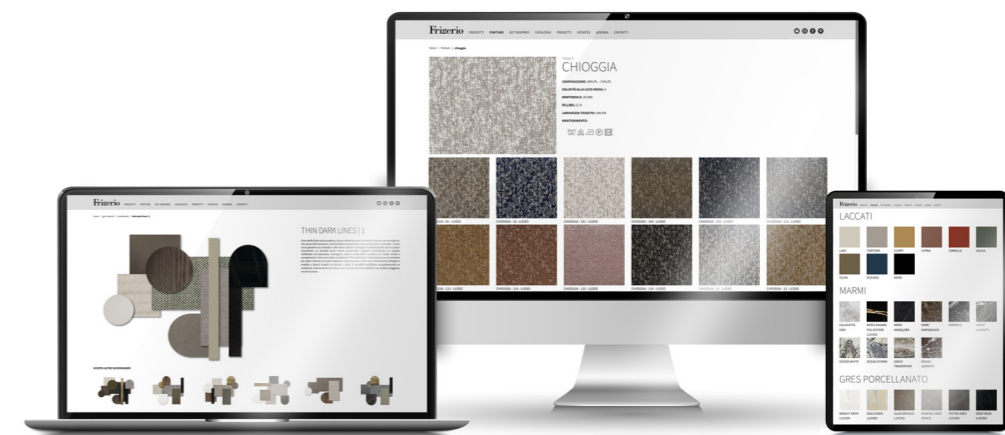

WWW.FRIGERIO.COM

Frigerio

Via Sant'Agata 63
22066 Mariano Comense (CO) - Italy
Tel. +39 031 5481225
info@frigerio.com
www.frigerio.com